



Equipos, Construcción e Instalaciones Hidráulicas

 **PadMex**
S.A. de C.V.

5604-7468
5604-7455

www.padmex.com



PISCINA PÚBLICA DEPORTIVA

SPORTS PUBLIC POOL

EXAGRES dedica una línea de producto específica para piscinas de uso público deportivo. Este tipo de recubrimiento, tanto en el vaso como en la playa, vestuarios o instalaciones complementarias, están expuestos a altas y variadas solicitudes debido a su función, las condiciones de uso y también el entorno donde se ubican.

El extrusionado es altamente resistente y ofrece solución a todos los requisitos que se plantean en una instalación de este tipo. Variedad de formas, colores, texturas y una gama completa de piezas especiales que dan respuesta a la demanda de diseño y calidad de técnicos especializados en la realización de proyectos y construcción de piscinas.

EXAGRES has a specific product line for sport public swimming pools. This type of cladding, both in the basin and on the deck, dressing rooms or complementary facilities, is exposed to high and varied requests due to its functions, conditions for use and also the environment where it is located.

The extruded stoneware is highly resistant and offers a solution to all requirements that arise in a facility of this type. Variety of shapes, colours, textures and a complete range of special pieces respond to the specialised technical quality and design needs for the undertaking of swimming pool construction and projects.





VENTAJAS ADVANTAGES

SISTEMA DE CORONACIÓN DESBORDANTE

Las piscinas de coronación desbordante son aquellas en las que el agua del vaso está a la misma altura que la playa. El agua se "desborda" por todo el perímetro de la piscina y se recoge en una canaleta que bordea el vaso. Normalmente en este canal se filtra el agua consiguiendo mantener el agua limpia.

Es el sistema utilizado mayoritariamente en piscinas de uso público deportivo (en función de las medidas y de las normativas vigentes en cada país su uso es obligatorio). Aporta ventajas higiénicas y estéticas como una excelente visibilidad y una superficie aparente mayor que la del vaso.

OVERFLOW EDGE SYSTEM

The overflowing deck pools are those where the water in the pool is at the same height as the deck. The water "overflows" around the perimeter of the pool and is collected in a channel that surrounds the pool. Normally, this channel filters the water, keeping the water clean.

This is the most commonly used system in public swimming pools (depending on the measurements and the valid regulations in each country, its use is obligatory). It provides hygienic and aesthetic advantages such as excellent visibility and a surface that seems larger than the size of the pool.



SISTEMAS DE CORONACIÓN DESBORDANTES / OVERFLOW EDGES SYSTEMS



SISTEMA SPORT. SPORT SYSTEM

(pág. 14-17)

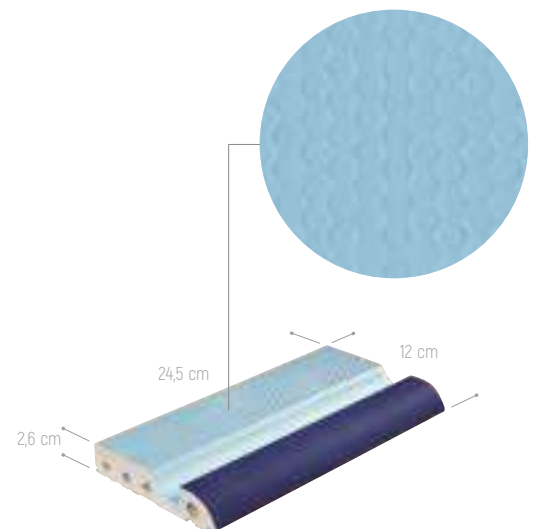

El sistema **SPORT** es un recubrimiento para piscinas, con coronación desbordante, que da óptimas soluciones a las zonas más complejas de piscinas polivalentes e instalaciones deportivas de uso público. Garantizando la máxima seguridad de manera homogénea. Algunas ventajas de este sistema:

- Antideslizamiento omnidireccional, homogéneo y más seguro, frente a otros relieves ranurados.
- Fácil colocación y limpieza del rejuntado más rápida.
- Mantenimiento rápido y seguro, debido al diseño del relieve.

The **SPORT** system is a cladding for pools, with overflowing system, that provides optimum solutions for the most complex areas of multi-purpose swimming pools and sports facilities for public use. Guaranteeing maximum safety in a standardised manner. Some advantages of this system:

- Omnidirectional anti-slip, standardised and safer, in comparison to grooved surfaces.
- Easy placement and faster cleaning of the grouting.
- Quick and easy maintenance, due to the design of the surface.

SISTEMA FINLANDÉS. FINLANDES SYSTEM

(pág. 18-21)

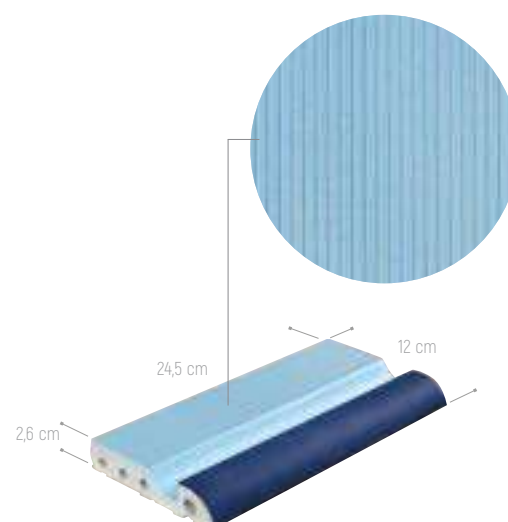
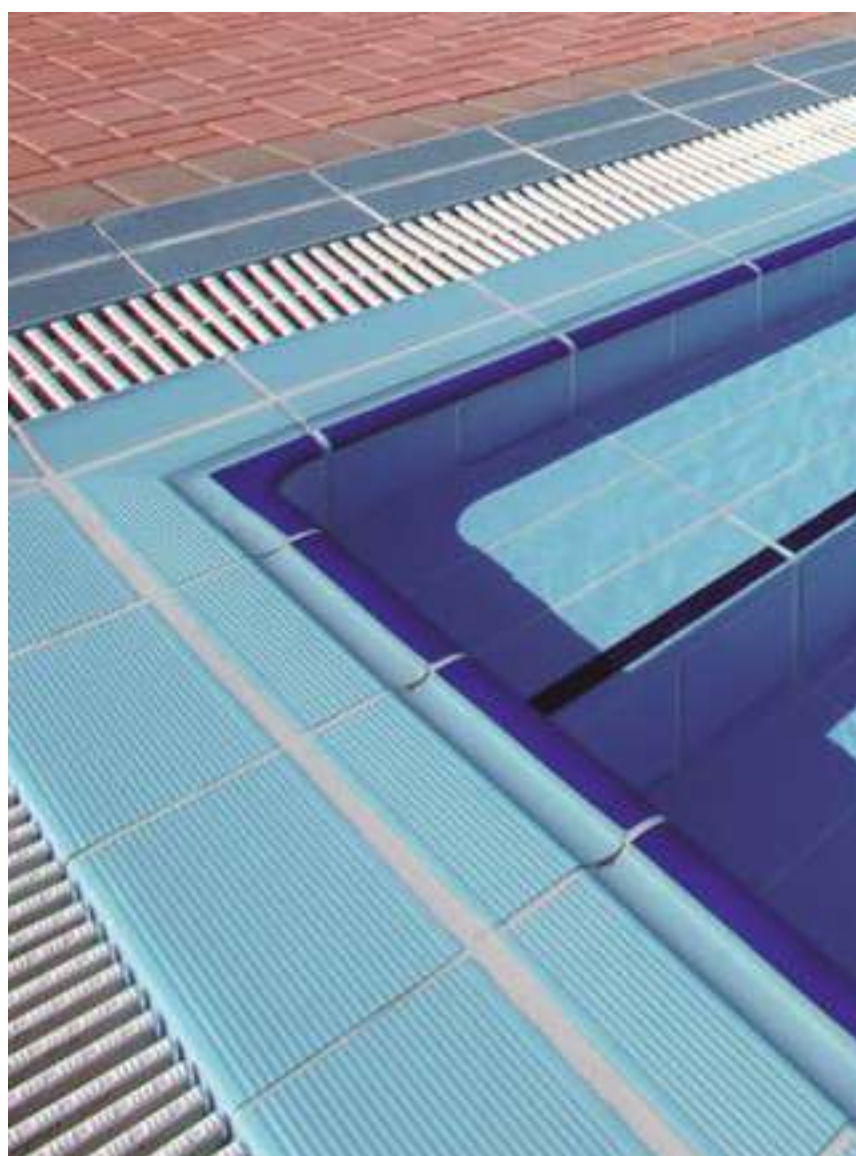

El sistema **FINLANDÉS** es el sistema más utilizado para piscinas desbordantes en instalaciones de uso público deportivo.

Piscinas polivalentes, piscinas comunitarias e instalaciones deportivas de uso público. Este sistema ofrece una serie de ventajas:

- Excelente visibilidad.
- Atenuación del oleaje en vasos deportivos de competición.
- Lámina de agua con superficie mayor que el vaso.

The **FINLANDES** system is the most commonly used system for overflowing swimming pools in public use facilities.

Multi-purpose swimming pools, community swimming pools and sports facilities for public use. This system offers a series of advantages:

- Excellent visibility.
- Alleviation of waves in competition sport swimming pools.
- Sheet of water with greater surface than the pool.

SISTEMA SPORT. SPORT SYSTEM / CORONACIÓN DESBORDANTE. OVERFLOW EDGE SYSTEM

GRES EXTRUIDIDO · EXTRUDED KLINKER · EN 14411 GRUPO A1b



GAMA CROMÁTICA · COLOUR RANGE



A B Pe Be



AMr BMr PeMr BeMr

PIEZAS CORONACIÓN PISCINA · POOL EDGE PIECES

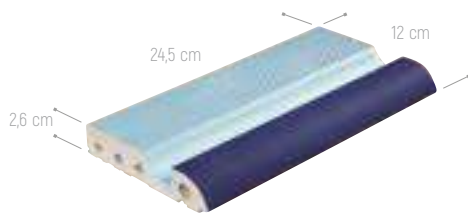

REF. 954
BORDE SPORT
12 x 24,5 x 2,6 cm - 4.7"x 9.6"x1.0"

- ANTI-SLIP CLASE 3
- R11
- CLASE C

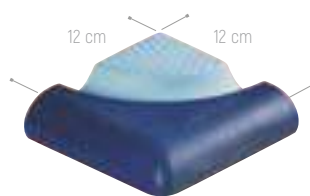

REF. 414
ÁNGULO EXT. SPORT
12 x 12 x 2,6 cm - 4.7"x 4.7"x1.0"

- ANTI-SLIP CLASE 3
- R11
- CLASE C

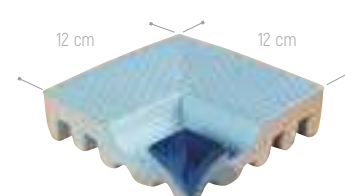

REF. 314
ÁNGULO INT. SPORT
12 x 12 cm - 4.7"x 4.7"

- ANTI-SLIP CLASE 3
- R11
- CLASE C



REF. 214
BORDE ESQUINA SPORT
17 x 17 cm - 6.7"x 6.7" r= 6 cm

- ANTI-SLIP CLASE 3
- R11
- CLASE C

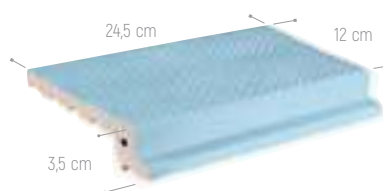

REF. 919
SOPORTE REJILLA SPORT
13,5 x 24,5 x 3,5 cm - 5.3"x 9.6"x1.4"

- ANTI-SLIP CLASE 3
- R11
- CLASE C

SISTEMA SPORT. SPORT SYSTEM / CORONACIÓN DESBORDANTE. OVERFLOW EDGE SYSTEM

GRES EXTRUIDIDO · EXTRUDED KLINKER EN 14411 GRUPO AIB



R11 C-3 CLASE C <math><1,5\%</math>

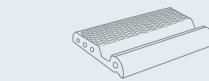
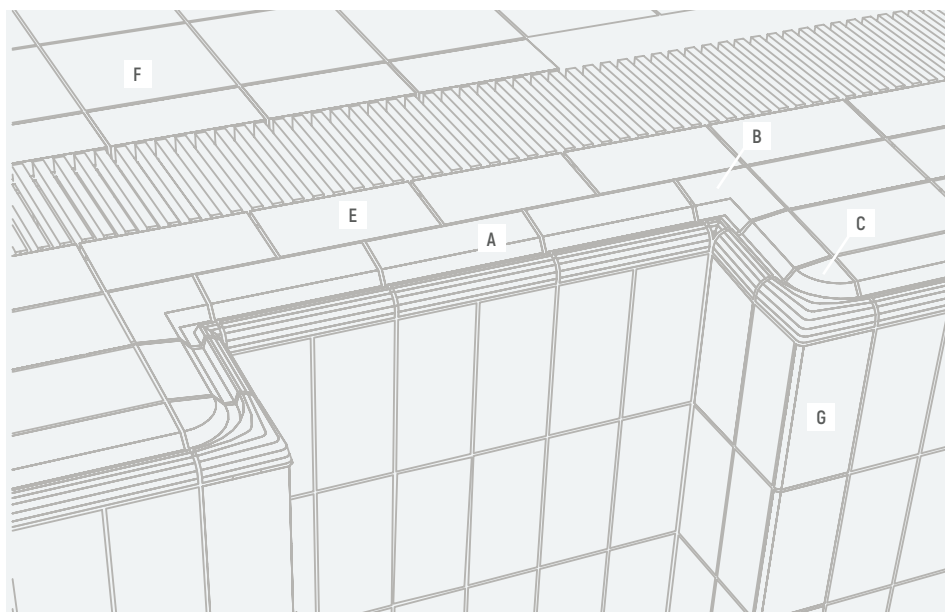
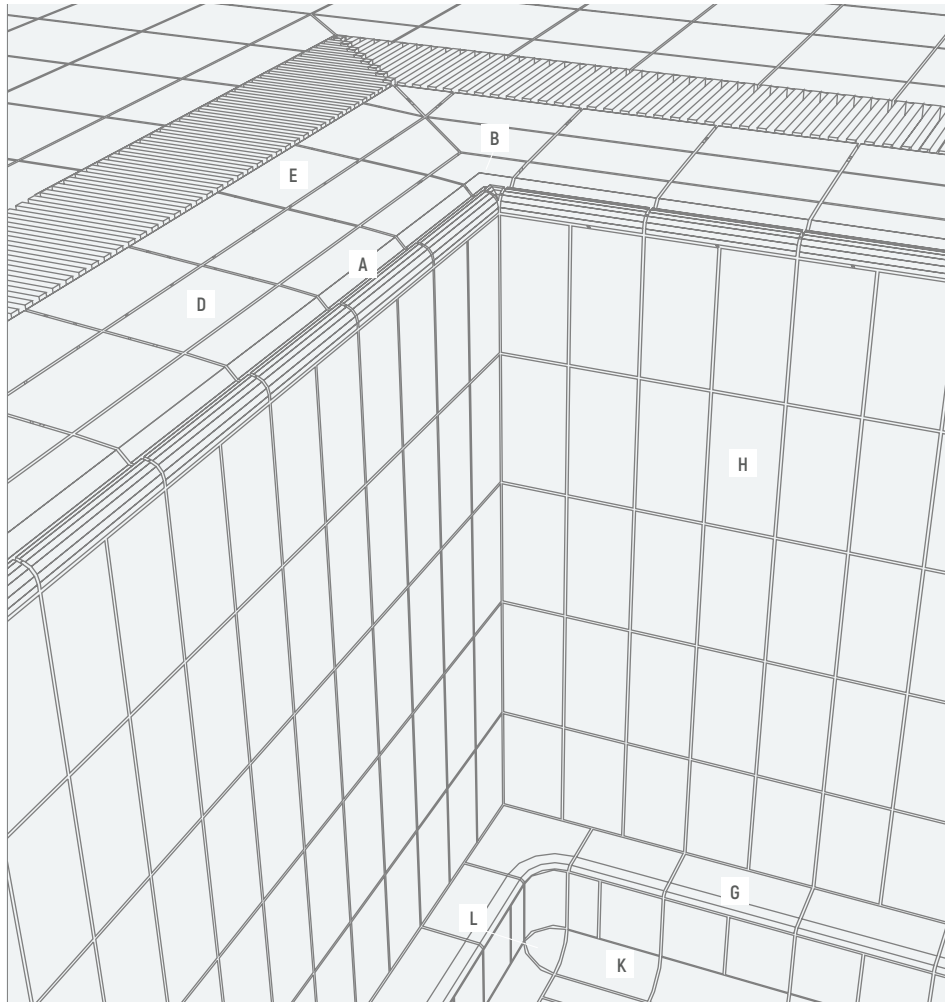

A Ref. 954
Borde Sport
12 x 24,5 x 2,6 cm



B Ref. 314
Ángulo Interior Sport
12 x 12 cm



C Ref. 414
Ángulo Exterior Sport
12 x 12 cm



D Ref. 104
Base Sport
12 x 24,5 x 0,9 cm



E Ref. 919
Soporte Rejilla Sport
13,5 x 24,5 x 3,5 cm



F Ref. 124
Base Sport
24,5 x 24,5 x 0,9 cm

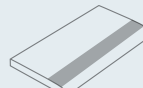

G Ref. 105
Romo
12 x 24,5 cm

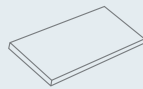

H Ref. 101
Base Lisa
12 x 24,5 x 0,9 cm

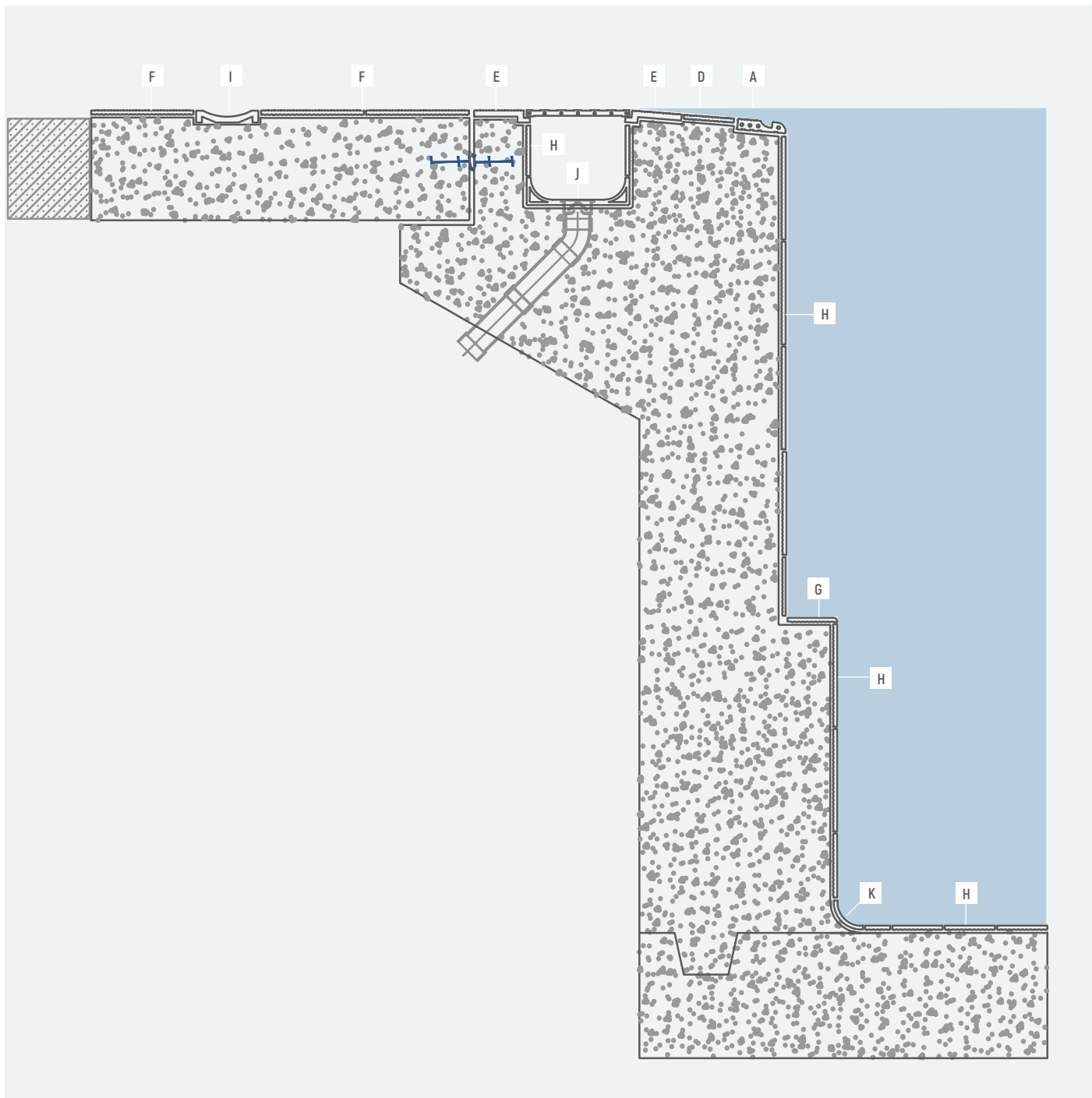

I Ref. 930
Canaleta
15 x 24,5 x 3,5 cm

J Ref. 230
Canaleta
24,5 x 24,5 x 6,5 cm

K Ref. 221
Media caña
24,5 x 8 cm

L Ref. 231
Uña
8 x 8 cm

SISTEMA FINLANDÉS. FINLANDES SYSTEM / CORONACIÓN DESBORDANTE. OVERFLOW EDGE SYSTEM

GRES EXTRUIDO · EXTRUDED KLINKER EN 14411 GRUPO A1b



R12



C-3



CLASE C



<1,5%

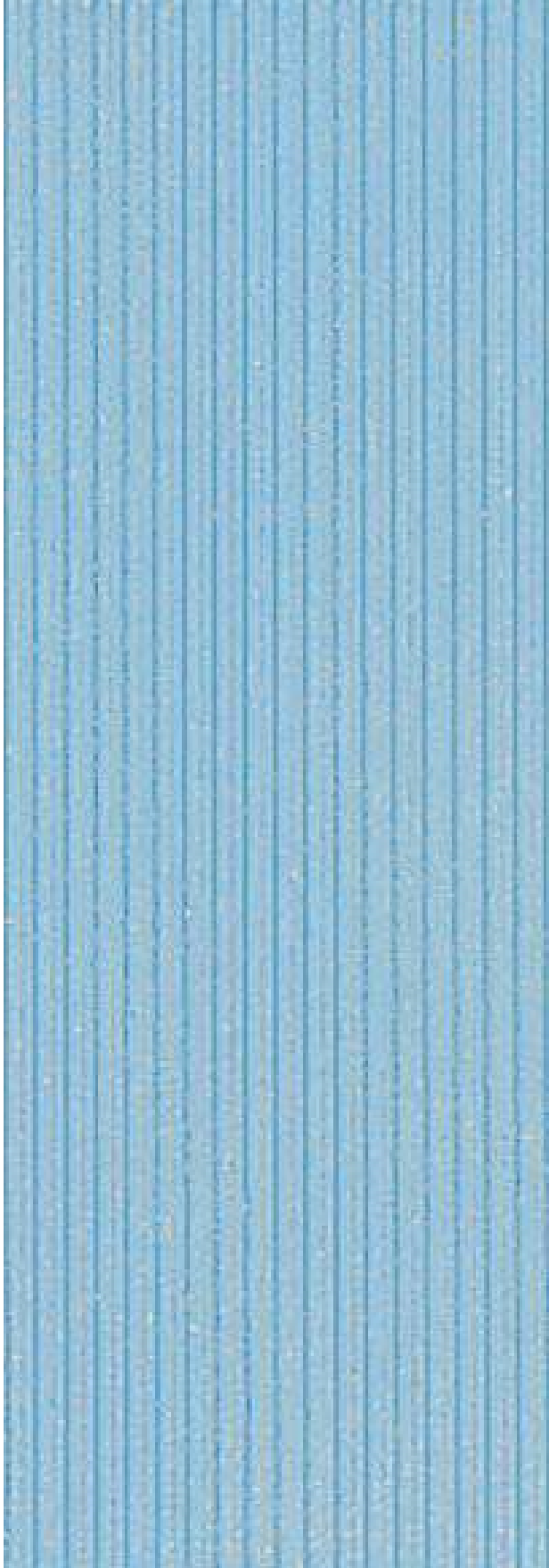

GAMA CROMÁTICA · COLOUR RANGE



A

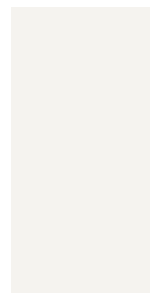

B



Pe



Be



AMr



BMr



PeMr



BeMr

PIEZAS CORONACIÓN PISCINA · POOL EDGE PIECES

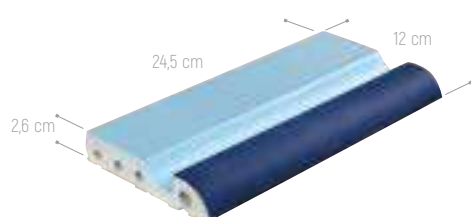



REF. 953
BORDE FINLANDÉS
12 x 24,5 x 2,6 cm - 4.7"x 9.6"x1.0"

-  ANTI-SLIP CLASE 3
-  R12
-  CLASE C



REF. 413
ÁNGULO EXT. FINLANDÉS
12 x 12 x 2,6 cm - 4.7"x 4.7"x1.0"

-  ANTI-SLIP CLASE 3
-  R12
-  CLASE C



REF. 313
ÁNGULO INT. FINLANDÉS
12 x 12 cm - 4.7"x 4.7"

-  ANTI-SLIP CLASE 3
-  R12
-  CLASE C



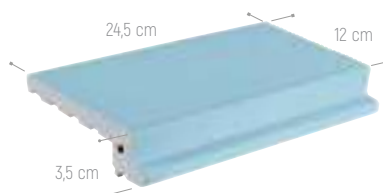

REF. 213
BORDE ESQUINA FINLANDÉS
17 x 17 cm - 6.7"x 6.7" r= 6 cm

-  ANTI-SLIP CLASE 3
-  R12
-  CLASE C



REF. 918
SOPORTE REJILLA RANURADA
13,5 x 24,5 x 3,5 cm - 5.3"x 9.6"x1.4"

-  ANTI-SLIP CLASE 3
-  R12
-  CLASE C

SISTEMA FINLANDÉS. FINLANDES SYSTEM /

CORONACIÓN DESBORDANTE. OVERFLOW EDGE SYSTEM

GRES EXTRUIDIDO · EXTRUDED KLINKER EN 14411 GRUPO A1b



R12 C-3 CLASE C <1,5%

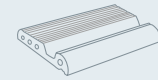
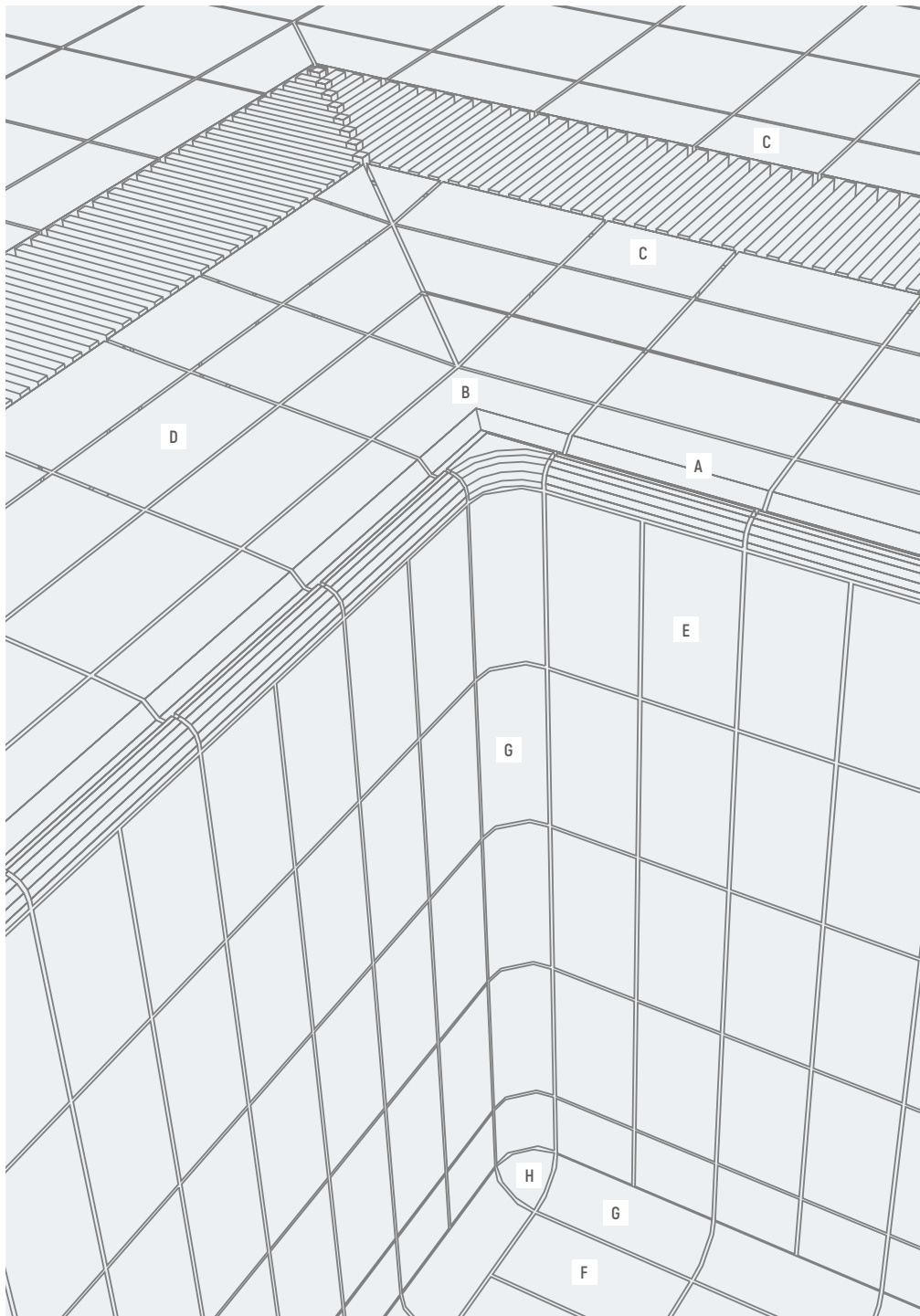

A Ref. 953
Borde Finlandés
12 x 24,5 x 2,6 cm

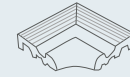

B Ref. 213
Borde Esquina Finlandés
17 x 17 cm



C Ref. 918
Soporte Rejilla Finlandés
13,5 x 24,5 x 3,5 cm

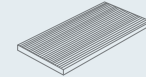

D Ref. 103
Base Ranurada
12 x 24,5 x 0,9 cm

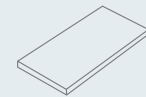

E Ref. 101
Base Lisa
12 x 24,5 x 0,9 cm

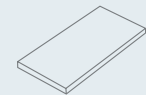

F Ref. 109
Base Antideslizante Suave /
Soft Anti-slip
12 x 24,5 x 0,9 cm



G Ref. 221
Media caña
24,5 x 8 cm



H Ref. 231
Uña
8 x 8 cm

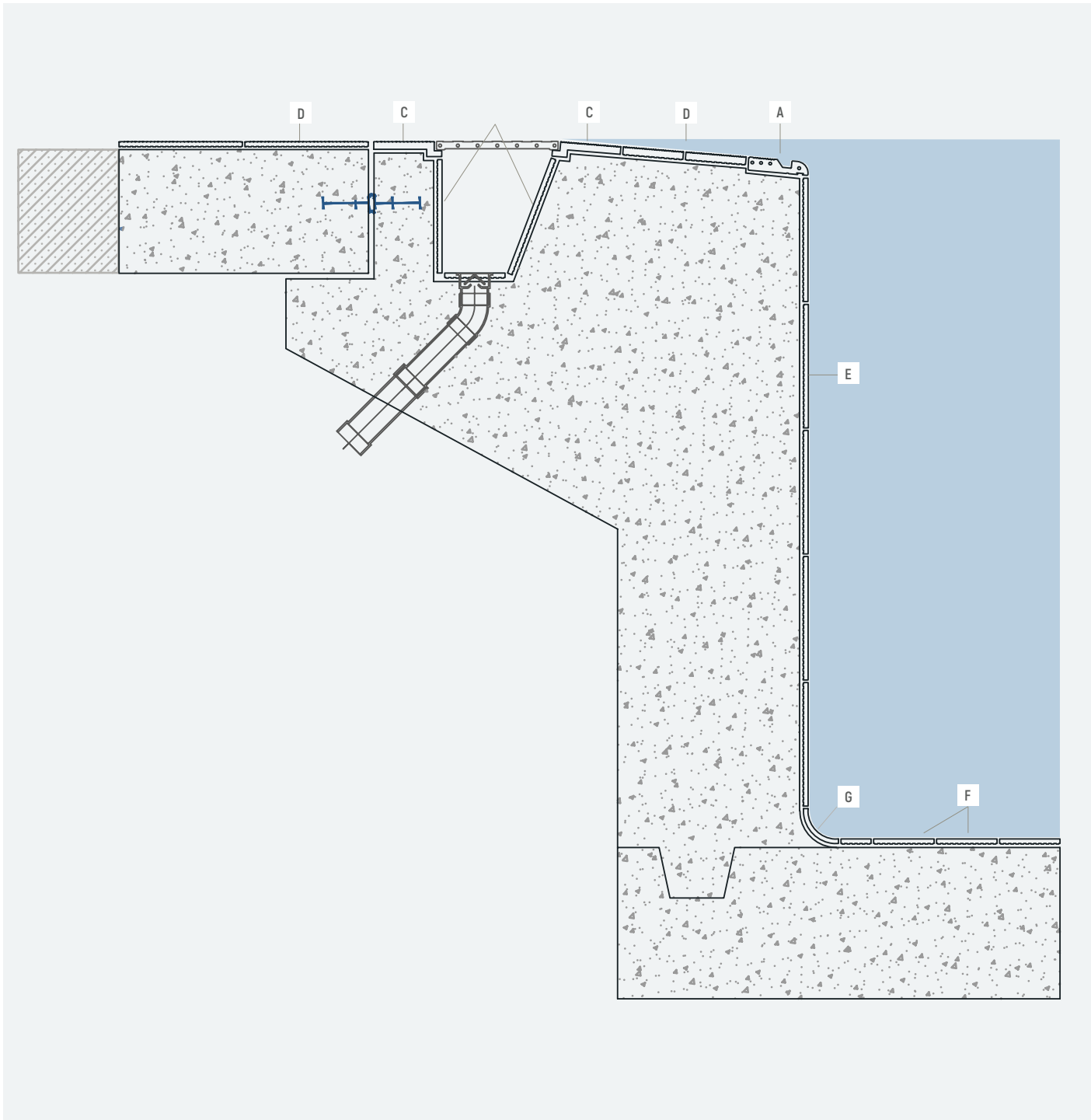

BASES. BASES /

PISCINA PÚBLICA DEPORTIVA. PUBLIC SPORTS POOL

GRES EXTRUIDO · EXTRUDED KLINKER · EN 14411 GRUPO Aib



<1,5 %



A

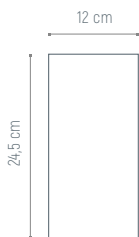

REF. 101
BASE LISA / SMOOTH
12 x 24,5 x 0,9 cm - 4.7"x 9.6"x0.4"

✂ 9 mm

☒ CLASE 1

GAMA CROMÁTICA. COLOUR RANGE

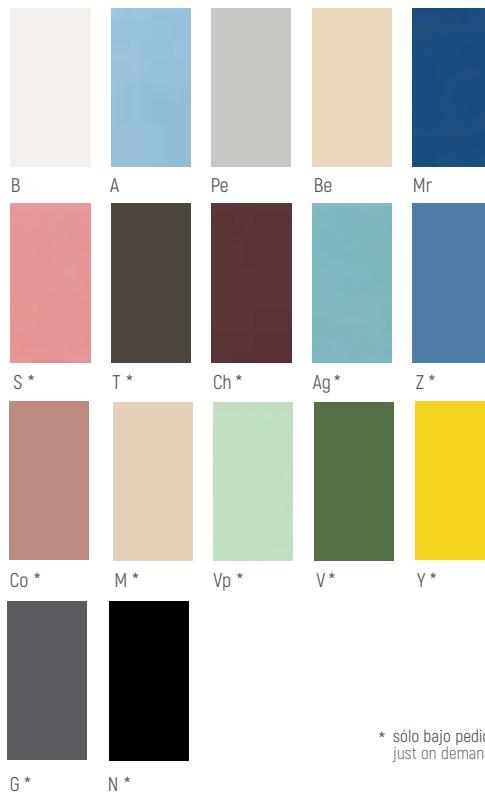

GAMA CROMÁTICA. COLOUR RANGE

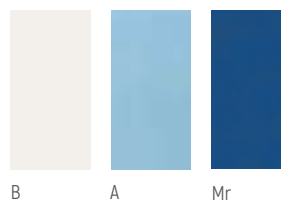

A

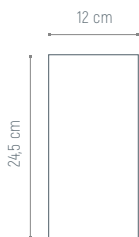

REF. 109
BASE ANTIDESLIZANTE SUAVE / SOFT ANTI-SLIP
12 x 24,5 x 0,9 cm - 4.7"x 9.6"x0.4"

✂ 9 mm

☒ ANTI-SLIP CLASE 3

☒ R10

☒ CLASE C



Las piezas tienen el dorso estriado en Cola de Milano, lo que mejora el agarre entre cerámica y soporte debido a que el mortero penetra en la pieza cerámica aumentando la superficie de sujeción de la baldosa.

The pieces have the ribbed backing in Milano Tail, which improves the grip between ceramic and support because the mortar penetrates the ceramic piece increasing the fixing surface of the tile.

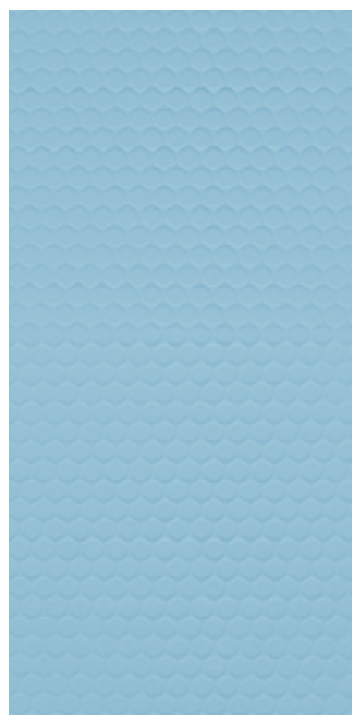
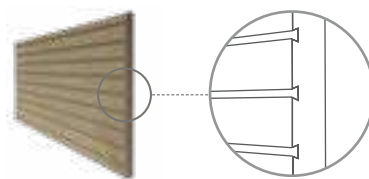

A

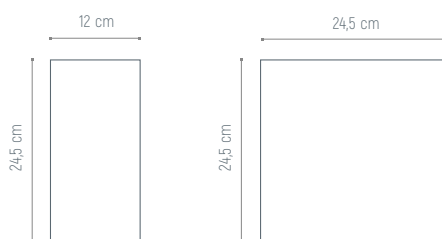

REF. 104

BASE SPORT

12 x 24,5 x 0,9 cm -
4.7"x 9.6"x0.4"

- ✕ 9 mm
- ☒ ANTI-SLIP CLASE 3
- ☒ R11
- ☒ CLASE C

REF. 124

BASE SPORT

24,5 x 24,5 x 0,9 cm -
9.6"x 9.6"x0.4"

- ✕ 9 mm
- ☒ ANTI-SLIP CLASE 3
- ☒ R11
- ☒ CLASE C

GAMA CROMÁTICA. COLOUR RANGE



B A Pe Be



A

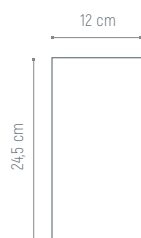

REF. 103

BASE RANURADA

12 x 24,5 x 0,9 cm - 4.7"x 9.6"x0.4"

- ✕ 9 mm
- ☒ ANTI-SLIP CLASE 3
- ☒ R12
- ☒ CLASE C

GAMA CROMÁTICA. COLOUR RANGE



B A Pe Be

PIEZAS ESPECIALES. SPECIAL TILES /

PISCINA PÚBLICA DEPORTIVA. PUBLIC SPORTS POOL

GRES EXTRUIDIDO · EXTRUDED KLINKER · EN 14411 GRUPO A1b



<1,5 %

Soluciones para aristas y cambios de plano en: Escaleras de acceso a pie · Descansillos · Muretes · Bancadas interiores y exteriores · Escaleras empotradas.
Solutions in corners and level changes in: Walking access stairs · Resting step · Walls · Internal / external benches · Built-in stairs.

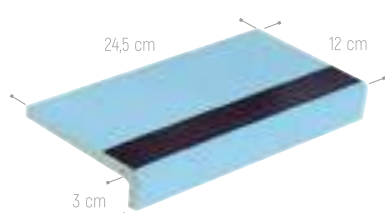

REF. 111
ANGULAR
12 x 24,5 x 3 cm - 4.7"x 9.6"x1.2"

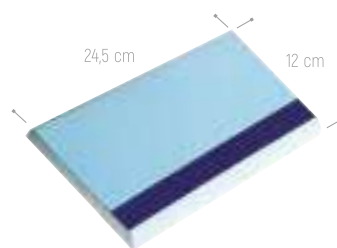
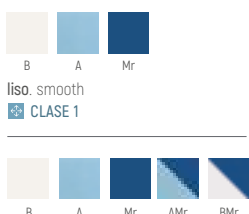

REF. 105
ROMO
12 x 24,5 x 0,9 cm - 4.7"x 9.6"x0.4"

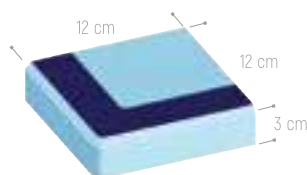
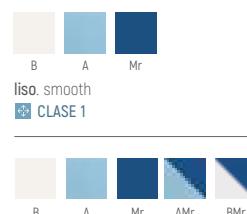

REF. 114
ESQUINA EXT. ANGULAR ROMO
12 x 12 x 3 cm - 4.7"x 4.7 "x1.2"

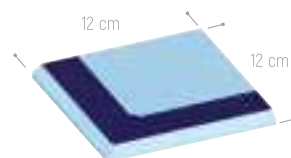

REF. 405
ESQUINA EXT. ROMO
12 x 12 x 0,9 cm - 4.7"x 4.7 "x0.4"

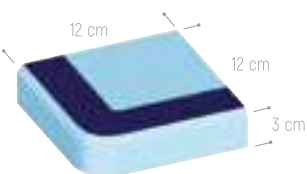

REF. 115
ESQUINA EXT. ANGULAR ARISTA
12 x 12 x 3 cm - 4.7"x 4.7 "x1.2"

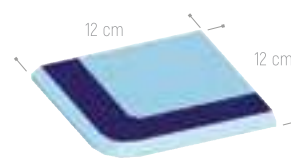

REF. 505
ESQUINA EXT. ROMO ARISTA
12 x 12 x 0,9 cm - 4.7"x 4.7 "x0.4"

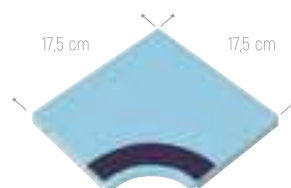

REF. 205
ESQUINA INTERIOR
17,5 x 17,5 x 0,9 cm - 6.7"x 6.7 "x0.4"
R 6 cm



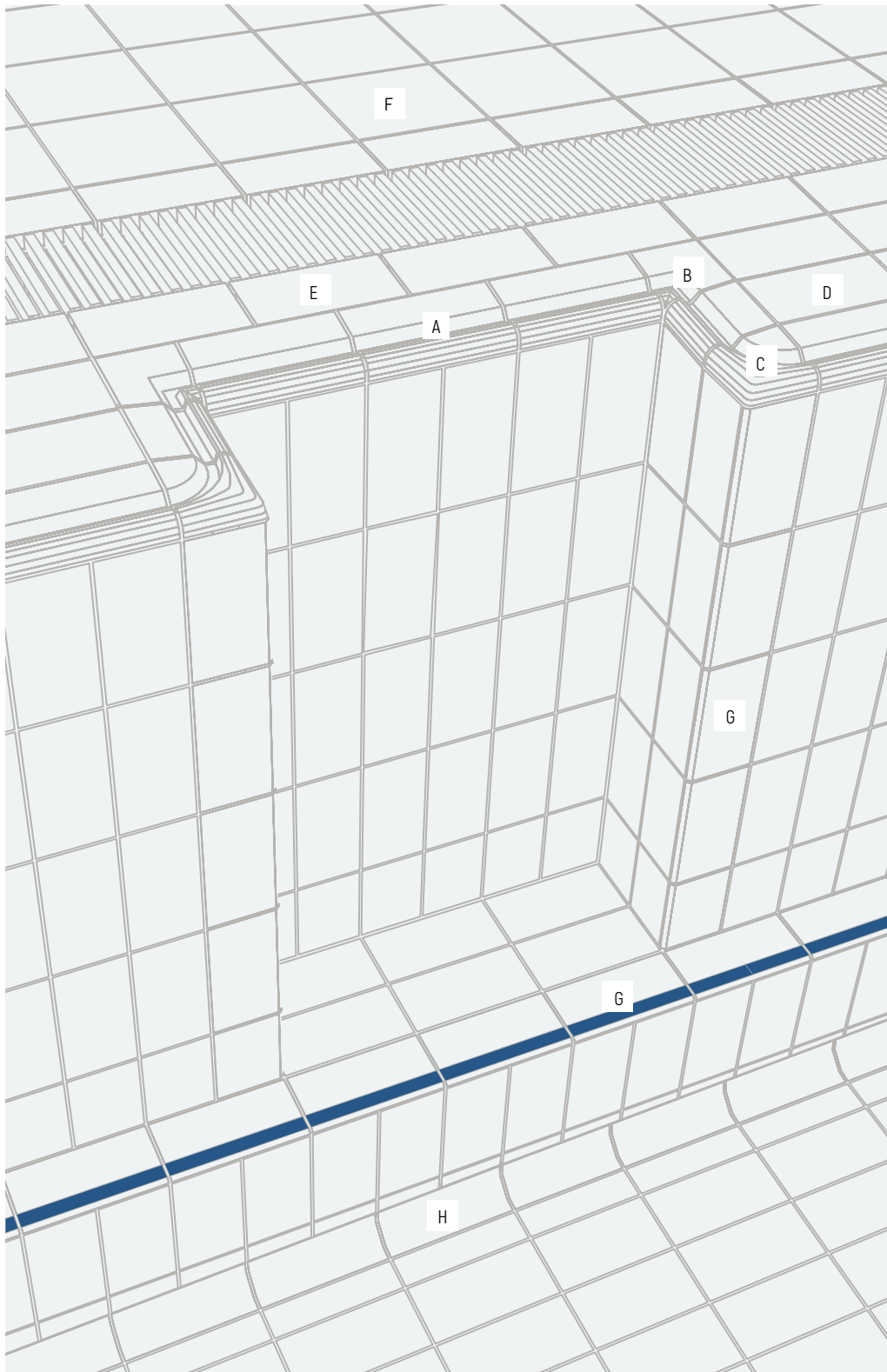

- 

A Ref. 954 / Ref. 953
Borde Sport / Finlandés
12 x 24,5 x 2,6 cm
- 

B Ref. 314 / 313
Ángulo Interior Sport / Finlandés
12 x 12 cm
- 

C Ref. 414 / 413
Ángulo Exterior Sport/Finlandés
12 x 12 cm
- 

D Ref. 104 / 103
Base Sport / Finlandés
12 x 24,5 x 0,9 cm
- 

E Ref. 919 / 918
Soporte Rejilla Sport/Finlandés
13,5 x 24,5 x 3,5 cm
- 

F Ref. 124
Base Sport
24,5 x 24,5 x 0,9 cm
- 

G Ref. 105
Romo
12 x 24,5 cm
- 

H Ref. 221
Media caña
24,5 x 8 cm

PIEZAS ESPECIALES. SPECIAL TILES /

PISCINA PÚBLICA DEPORTIVA. PUBLIC SPORTS POOL

GRES EXTRUIDIDO · EXTRUDED KLINKER · EN 14411 GRUPO A1b



<1,5 %

Soluciones para rincones, escocías y aristas.
Solutions for corners and angles.



REF. 321
ARISTA
24,5 x 8 cm - 9.6"x3.1" - R6 cm



REF. 221
MEDIA CAÑA
24,5 x 8 cm - 9.6"x3.1" - R6 cm

GAMA CROMÁTICA. COLOUR RANGE

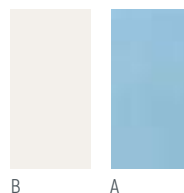

REF. 331
UÑA ARISTA
8 x 8 cm - 3.1"x3.1" - R6 cm

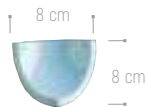

REF. 231
UÑA
8 x 8 cm - 3.1"x3.1" - R6 cm

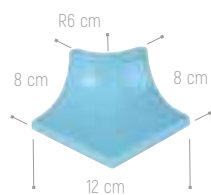

REF. 341
ÁNGULO EXTERIOR ARISTA
12 x 8 x 8 cm - 4.7 "x3.1" x 3.1"

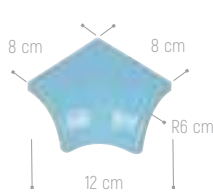

REF. 342
ÁNGULO INTERIOR ARISTA
12 x 8 x 8 cm - 4.7 "x3.1" x 3.1"

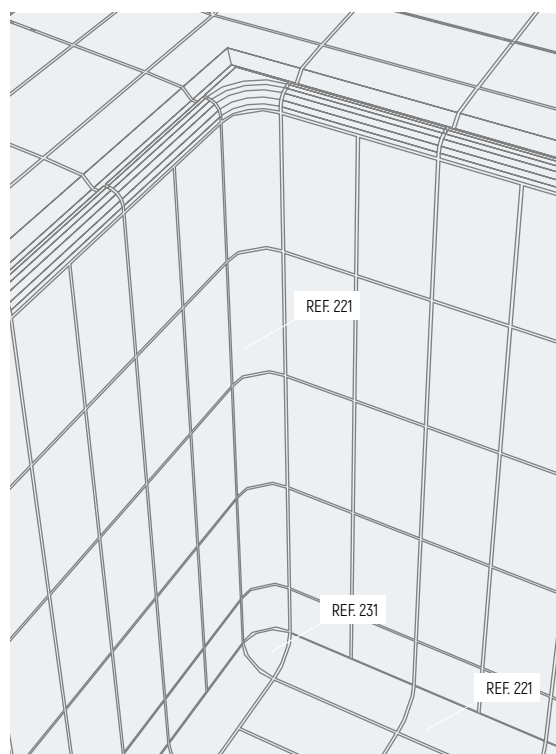

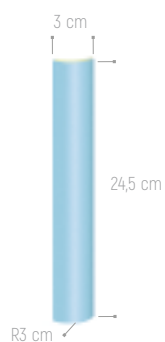

REF. 322
ARISTA
24,5 x 3 cm - 9.6"x1.2" - R3 cm



REF. 222
MEDIA CAÑA
24,5 x 4 cm - 9.6"x1.6" - R3 cm

GAMA CROMÁTICA. COLOUR RANGE

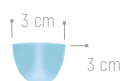
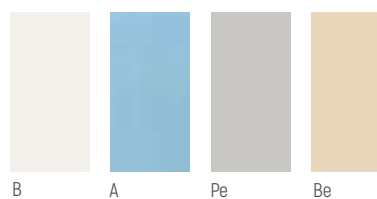

REF. 332
UÑA ARISTA
3 x 3 cm - 1.2"x1.2" - R3 cm



REF. 232
UÑA
4 x 4 cm - 1.6"x1.6" - R3 cm



REF. 942
ÁNGULO EXTERIOR
12 x 4,75 x 4,75 cm - 4.7"x1.9"x1.9" - R3 cm



REF. 941
ÁNGULO INTERIOR
12 x 4,75 cm - 4.7"x1.9" - R3 cm

PIEZAS ESPECIALES. SPECIAL TILES /

PISCINA PÚBLICA DEPORTIVA. PUBLIC SPORTS POOL

GRES EXTRUIDIDO · EXTRUDED KLINKER EN 14411 GRUPO AIB



<1,5 %

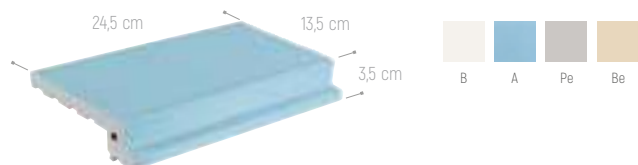

REF. 918
SOPORTE REJILLA RANURADA
13,5 x 24,5 x 3,5 cm - 5.3"x 9.6"x1.4"

- ANTI-SLIP CLASE 3
- R12
- CLASE C

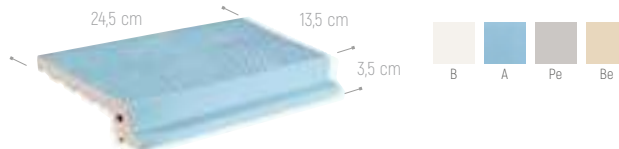

REF. 919
SOPORTE REJILLA SPORT
13,5 x 24,5 x 3,5 cm - 5.3"x 9.6"x1.4"

- ANTI-SLIP CLASE 3
- R11
- CLASE C

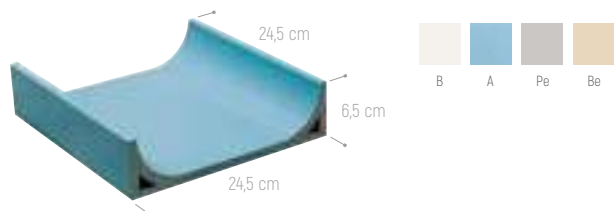

REF. 230
CANALETA
24,5 x 24,5 x 6,5 cm - 9.6"x 9.6"x2.6"

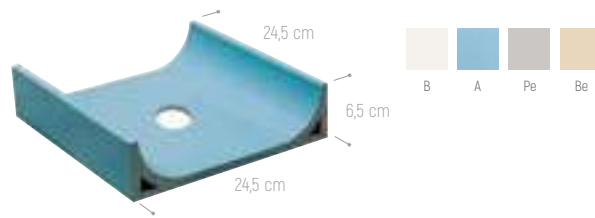

REF. 230 CON SUMIDERO
CANALETA CON SUMIDERO
24,5 x 24,5 x 6,5 cm - 9.6"x 9.6"x2.6"
ø 50-65 mm

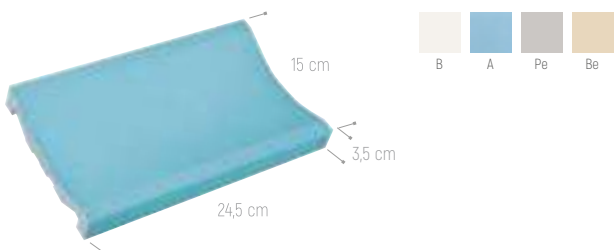

REF. 930
CANALETA
15 x 24,5 x 3,5 cm - 5.9"x 9.6"x1.4"

- ANTI-SLIP CLASE 3
- R10
- CLASE C



REF. 930 CON SUMIDERO
CANALETA CON SUMIDERO
15 x 24,5 x 3,5 cm - 5.9"x 9.6"x1.4"
ø 50-65 mm

- ANTI-SLIP CLASE 3
- R10
- CLASE C

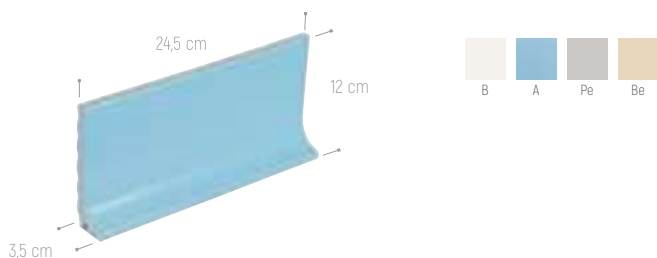

REF. 931
ZÓCALO SANITARIO CON
ESCOCIA ESMALTADO
12 x 24,5 x 3,5 cm - 4.7"x 9.6"x0.4"

DECORADOS. DECORS

1.35m.

REF. NÚMERO DE PROFUNDIDAD*
12 x 24,5 x 0,9 cm - 4.7"x 9.6"x0.4"

* sólo bajo pedido
just on demand

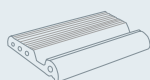

A Ref. 953
Borde Finlandés
12 x 24,5 x 2,6 cm



B Ref. 213
Borde Esquina Finlandés
17 x 17 cm



C Ref. 918
Soporte Rejilla Finlandés
13,5 x 24,5 x 3,5 cm

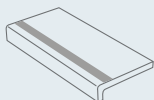

D Ref. 111
Angular
12 x 24,5 x 3 cm



E Ref. 230
Canaleta
24,5 x 24,5 x 6,5 cm

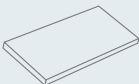

F Ref. 109
Base Antideslizante Suave
12 x 24,5 x 0,9 cm

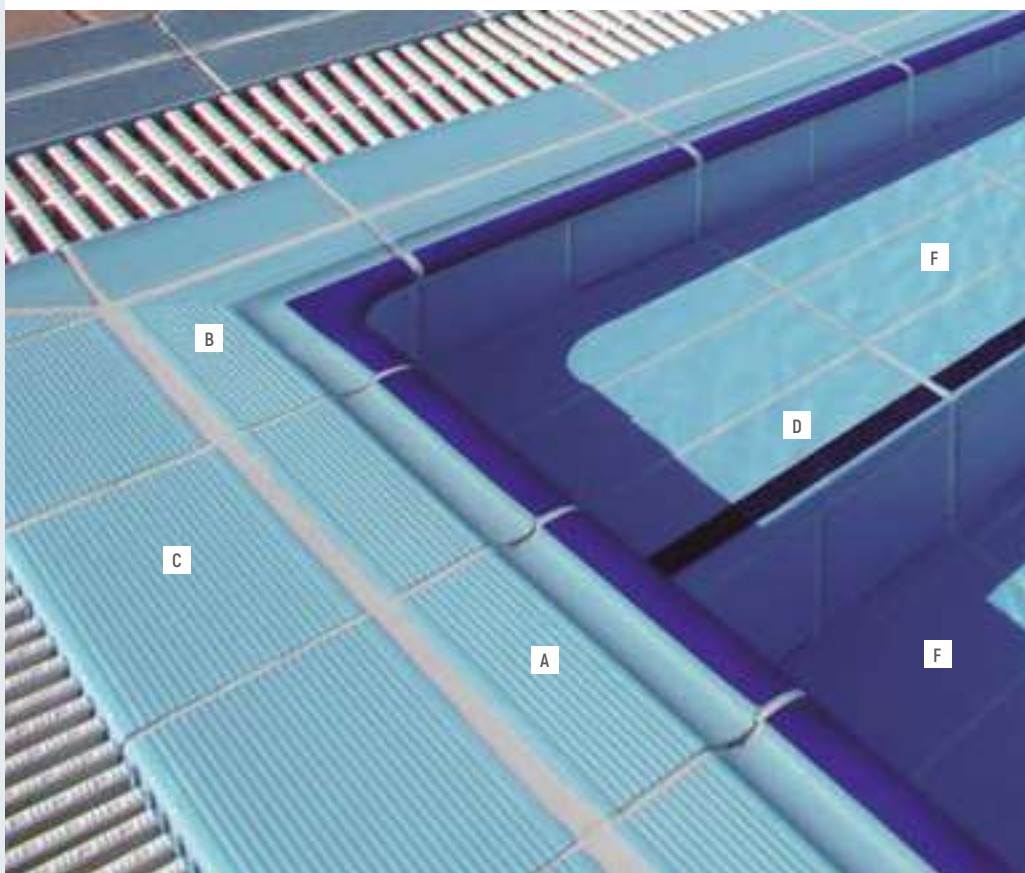
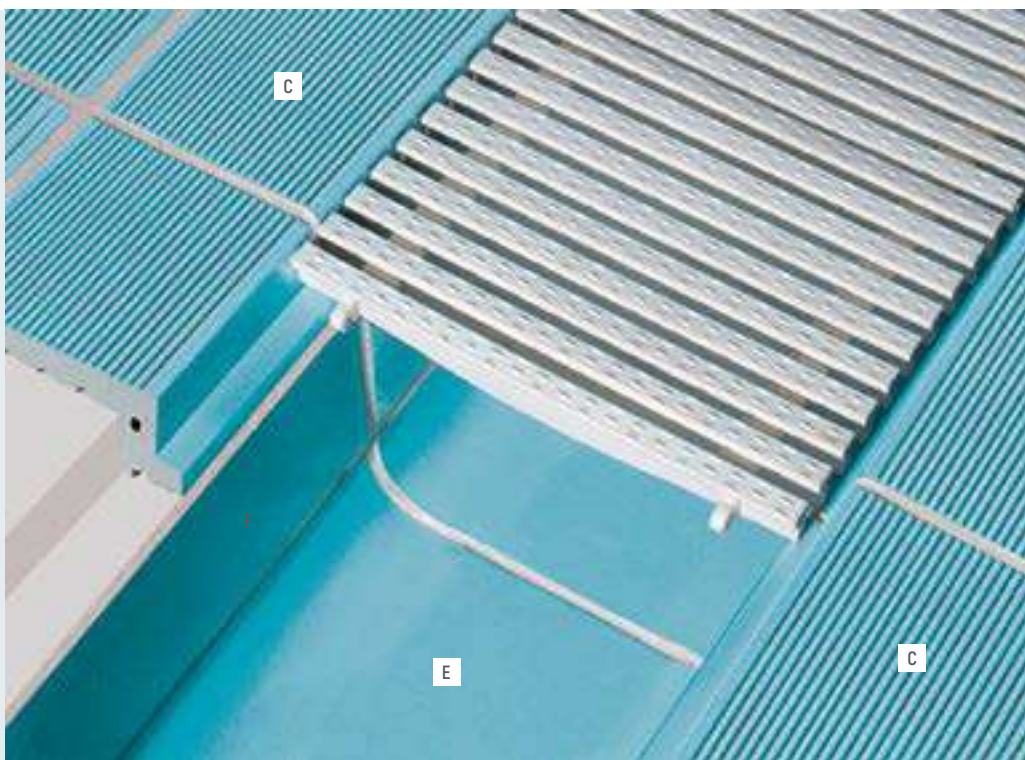

PROYECTOS PROJECTS

En las construcciones de piscinas deportivas se engloba una diversa tipología de obras, primando en ellas la perfecta ejecución del proyecto, de manera que los usuarios puedan utilizarlas con la mejor funcionalidad posible y disfrutando de la máxima calidad en las terminaciones. El producto de Exagres cumple ampliamente la Normativa aplicada en la construcción de este tipo de piscinas, y ofrece diferentes soluciones técnicas adecuadas para cada zona de uso.

En el área de piscina deportiva, Exagres cuenta con dilatada experiencia, desarrollando diferentes y variados proyectos de piscinas deportivas públicas, o piscinas deportivas en centros lúdicos y hoteles, tanto en el mercado nacional como internacional.

Swimming pool construction projects encompass a wide variety of types and designs, but they all focus on achieving the perfect result so that their users can enjoy maximum functionality and finished products of the highest quality. Exagres' products meet the loftiest standards for use in constructing pools and they can be adapted to each individual client and space thanks to our range of customisable technical solutions.

Exagres has extensive experience in sports swimming pools, designing a diverse range of public pools, in addition to sports pools in leisure centres and hotels, both in Spain and throughout the world.





PROYECTOS /

PROJECTS

PROYECTO · PROJECT: PISCINA OLÍMPICA MUNICIPAL UBICACIÓN · LOCATION: CASTELLÓN, ESPAÑA SISTEMA · SYSTEM: SISTEMA SPORT



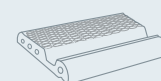

Ref. 954 PeMr
Borde Sport
12 x 24,5 x 2,6 cm



Ref. 414 PeMr
Ángulo Exterior Sport
12 x 12 cm



Ref. 104 Pe
Base Sport
12 x 24,50 cm e= 9 mm



Ref. 919 Pe
Soporte Rejilla Sport
13,5 x 24,5 x 3,5 cm



Ref. 314 PeMr
Ángulo Interior Sport
12 x 12 cm



Ref. 930 Pe
Canaleta
15 x 24,5 x 3,5 cm



Ref. 124 Pe
Base Sport
12 x 24,50 cm e= 9 mm

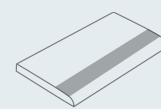

Ref. 105 AMr
Romo
12 x 24,5 cm

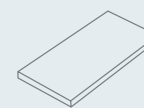

Ref. 109 A / Mr
Base Antideslizante / Anti-slip
12 x 24,50 cm e= 9 mm

Ref. 101 A / Mr
Base Liso / Smooth
12 x 24,50 cm e= 9 mm

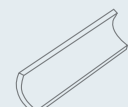

Ref. 221 A
Media caña
24,5 x 8 cm



Pe PeMr A AMr Mr

PROYECTOS /

PROJECTS

PROYECTO · PROJECT: PISCINA UNIVERSIDAD

UBICACIÓN · LOCATION: LIMERYCK, IRLANDA

SISTEMA · SYSTEM: SISTEMA FINLANDÉS - CORONACIÓN DESBORDANTE



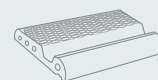

Ref. 954 BMr
Borde Sport
12 x 24,5 x 2,6 cm



Ref. 919 Mr
Soporte Rejilla Sport
13,5 x 24,5 x 3,5 cm



Ref. 314 BMr
Ángulo Interior Sport
12 x 12 cm

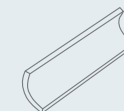

Ref. 221 A
Media caña
24,5 x 8 cm



Ref. 104 B
Base Sport
12 x 24,50 cm e= 9 mm

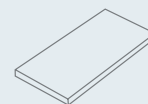

Ref. 109 B / Mr
Base Antideslizante / Anti-slip
12 x 24,50 cm e= 9 mm

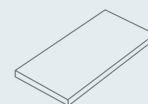

Ref. 101 A / Mr
Base Liso / Smooth
12 x 24,50 cm e= 9 mm

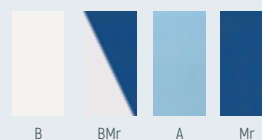

B BMr A Mr

PROYECTOS /

PROJECTS

PROYECTO · PROJECT: PISCINA PROVINCIAL UBICACIÓN · LOCATION: CASTELLÓN, ESPAÑA SISTEMA · SYSTEM: SISTEMA FINLANDÉS/SPORT - CORONACIÓN DESBORDANTE



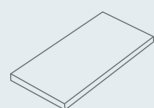

Ref. 101 A / Mr
Base Liso / Smooth
12 x 24,50 cm e= 9 mm

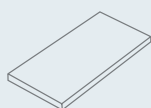

Ref. 109 A / Mr
Base Antideslizante / Anti-slip
12 x 24,50 cm e= 9 mm

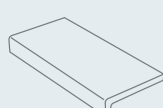

Ref. 111 Mr
Angular
12 x 24,5 x 3 cm

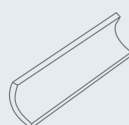

Ref. 221 A
Media caña
24,5 x 8 cm

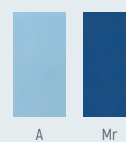

PROYECTOS /

PROJECTS

PROYECTO · PROJECT: PISCINA CLIMATIZADA MUNICIPAL

UBICACIÓN · LOCATION: BURJASSOT, VALENCIA, ESPAÑA

SISTEMA · SYSTEM: SISTEMA FINLANDÉS - CORONACIÓN DESBORDANTE

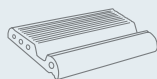

Ref. 953 AMr
Borde Finlandés
12 x 24,5 x 2,6 cm

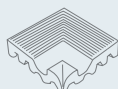

Ref. 313 AMr
Áng. Interior Finlandés
12 x 12 cm

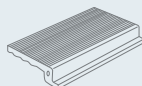

Ref. 918 A
Soporte Rejilla Ranurada
13,5 x 24,5 x 3,5 cm

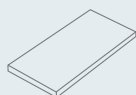

Ref. 109 A / Mr
Base Antideslizante / Anti-slip
12 x 24,50 cm e= 9 mm

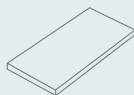

Ref. 101 A / Mr
Base Liso / Smooth
12 x 24,50 cm e= 9 mm

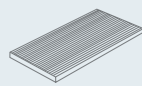

Ref. 103 A
Base Ranurada
12 x 24,50 cm e= 9 mm

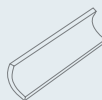

Ref. 221 A
Media Caña
24,5 x 8 cm

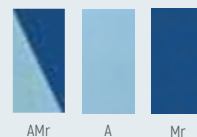

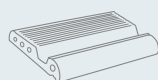

Ref. 953 AMr
Borde Finlandés
12 x 24,5 x 2,6 cm

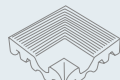

Ref. 313 AMr
Ang. Interior Finlandés
12 x 12 cm

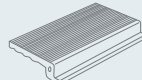

Ref. 918 A
Soporte Rejilla Ranurada
13,5 x 24,5 x 3,5 cm

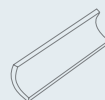

Ref. 221 A
Media Caña
24,5 x 8 cm

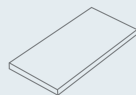

Ref. 109 A / Mr
Base Antideslizante / Anti-slip
12 x 24,50 cm e= 9 mm

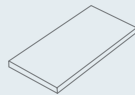

Ref. 101 A / Mr
Base Liso / Smooth
12 x 24,50 cm e= 9 mm



Ref. 104 Pe
Base Sport
12 x 24,50 cm e= 9 mm

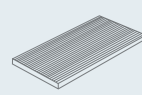

Ref. 103 A
Base Ranurada
12 x 24,50 cm e= 9 mm



Ref. 124 Pe
Base Sport
12 x 24,50 cm e= 9 mm



AMr

A

Mr

Pe

PROYECTOS /

PROJECTS

PROYECTO · PROJECT: PISCINA CLIMATIZADA MUNICIPAL

UBICACIÓN · LOCATION: MORALZARZAL, MADRID, ESPAÑA

SISTEMA · SYSTEM: SISTEMA FINLANDÉS - CORONACIÓN DESBORDANTE

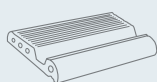

Ref. 953 AMr
Borde Finlandés
12 x 24,5 x 2,6 cm



Ref. 313 AMr
Áng. Interior Finlandés
12 x 12 cm

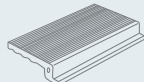

Ref. 918 A
Soporte Rejilla Ranurada
13,5 x 24,5 x 3,5 cm



Ref. 413 A / Mr
Angulo Exterior Finlandés
12 x 12 x 2,6 cm

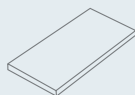

Ref. 109 A / Mr
Base Antideslizante /
Anti-slip
12 x 24,50 cm e= 9 mm

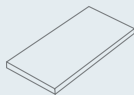

Ref. 101 A / Mr
Base Liso / Smooth
12 x 24,50 cm e= 9 mm



Ref. 104 Pe
Base Sport
12 x 24,50 cm e= 9 mm

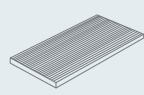

Ref. 103 A
Base Ranurada
12 x 24,50 cm e= 9 mm

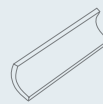

Ref. 221 A
Media Caña
24,5 x 8 cm

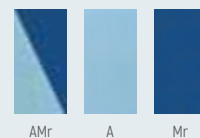



PROYECTO · PROJECT: PISCINA HOTEL ECUMANI

UBICACIÓN · LOCATION: NÁPOLES, ITALIA

SISTEMA · SYSTEM: SISTEMA SPORT - CORONACIÓN DESBORDANTE

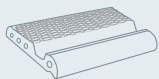

Ref. 954 AMr
Borde Sport
12 x 24,5 x 2,6 cm



Ref. 314 AMr
Ángulo Interior Sport
12 x 12 cm



Ref. 919 A
Soporte Rejilla Sport
13,5 x 24,5 x 3,5 cm

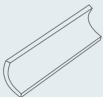

Ref. 221 A
Media Caña
24,5 x 8 cm



Ref. 104 A
Base Sport
12 x 24,50 cm e= 9 mm

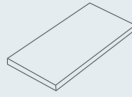

Ref. 109 A
Base Antideslizante /
Anti-slip
12 x 24,50 cm e= 9 mm

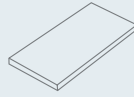

Ref. 101 A / Mr
Base Liso / Smooth
12 x 24,50 cm e= 9 mm



AMr

A

Mr

PROYECTOS /

PROJECTS

PROYECTO · PROJECT: PISCINA MUNICIPAL

UBICACIÓN · LOCATION: FUENTEÁLAMO, ESPAÑA

SISTEMA · SYSTEM: SISTEMA FINLANDÉS - CORONACIÓN DESBORDANTE

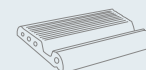

Ref. 953 AMr
Borde Finlandés
12 x 24,5 x 2,6 cm

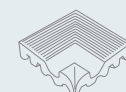

Ref. 313 AMr
Áng. Interior Finlandés
12 x 12 cm

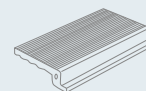

Ref. 918 A
Soporte Rejilla Ranurada
13,5 x 24,5 x 3,5 cm

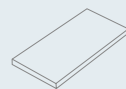

Ref. 109 AMr
Base Antideslizante /
Anti-slip
12 x 24,50 cm e= 9 mm

Ref. 101 A / Mr / V / Y / C / B
Base Liso / Smooth
12 x 24,50 cm e= 9 mm

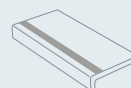

Ref. 111 AMr
Angular
12 x 24,5 x 3 cm



Ref. 114 AMr
Esq. Ext. Angular Romo
12 x 12 cm

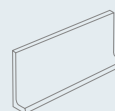

Ref. 931 Be
Zócalo Sanitario
12 x 24,5 cm



A

Mr



PROYECTO · PROJECT: PISCINA MUNICIPAL

UBICACIÓN · LOCATION: BENIPARRELL, VALENCIA, ESPAÑA

SISTEMA · SYSTEM: SISTEMA FINLANDÉS - CORONACIÓN DESBORDANTE

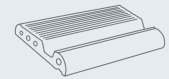

Ref. 953 AMr
Borde Finlandés
12 x 24,5 x 2,6 cm

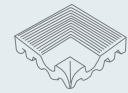

Ref. 313 AMr
Áng. Interior Finlandés
12 x 12 cm

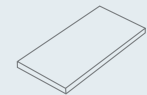

Ref. 109 A / Mr
Base Antideslizante / Anti-slip
12 x 24,50 cm e= 9 mm

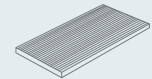

Ref. 103 A
Base Ranurada
12 x 24,50 cm e= 9 mm

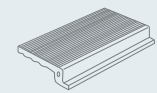

Ref. 918 A
Soporte Rejilla Ranurada
13,5 x 24,5 x 3,5 cm



Ref. 413
Ángulo Exterior Finlandés
12 x 12 x 2,6 cm



A

Mr



DEPORTIVO DURANGO DEL. COYOACAN



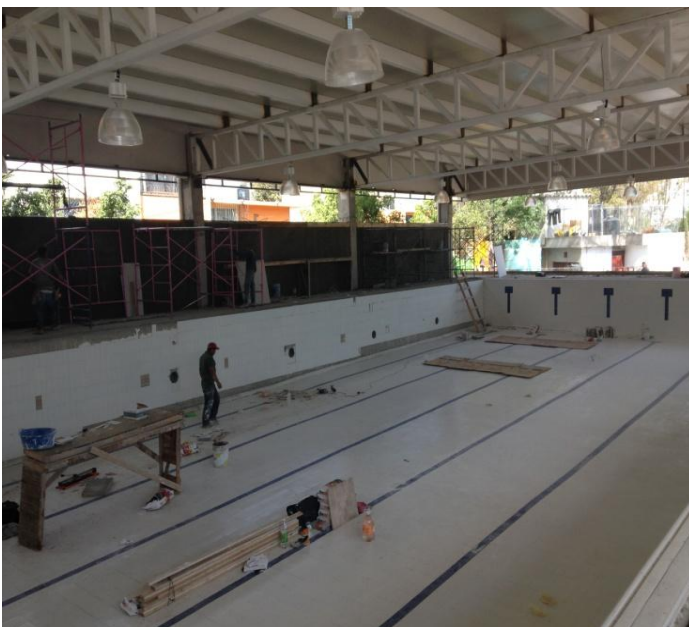



DEPORTIVO LOS CULHUACANES TAXQUEÑA - COYOACAN







DEPORTIVO LA CAÑADA
ALVARO OBREGON



II LA CIENCIA Y EL ARTE DE LAS ALBERCAS II
Piscinas PadMex
s.a. de c.v.

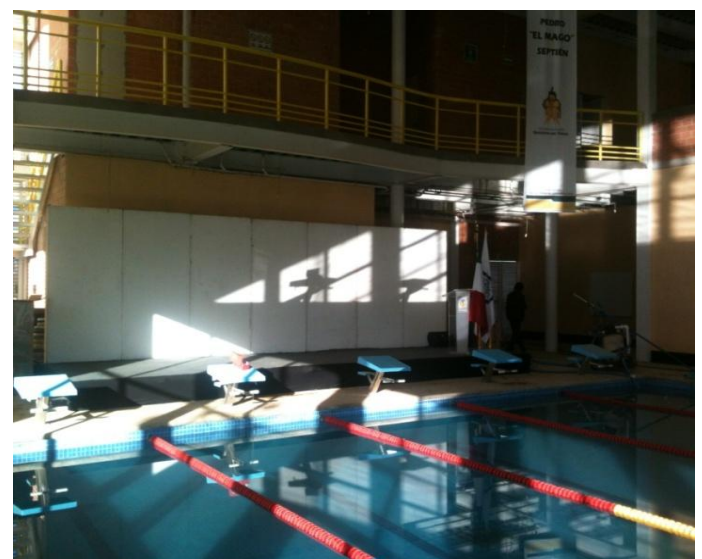
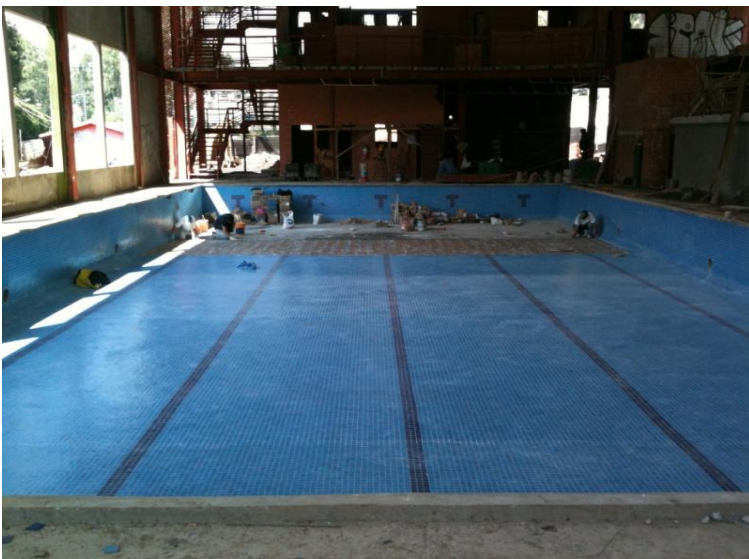

DEPORTIVO LA CAÑADA
ALVARO OBREGON
PEDRO MAGO SEPTIEN



Equipos, Construcción e Instalaciones Hidráulicas

 **PadMex** **5604-7468**
5604-7455
S.A. de C.V. www.padmex.com